

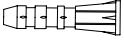

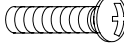

PARTS & ASSEMBLY SHEET

Fixture Name: Brookfield 5221-4 CH, ORB, PW and 5334 RBZ

This fixture assembled PO: _____ Date: _____

Notice: Please review the parts listing and check for all parts before assembling the fixture. If any parts are missing or damaged, please note on this sheet and contact the place of purchase to arrange for replacement parts.

PARTS LIST		Company Name: _____ Co. Account #: _____	
to be filled out by retailer			
Anchor	2ea 	Junction Box Screw	2ea 
Anchor Screw	2ea 	Wire Connector	2ea 
Green Ground Screw	1ea 	Deco Nut (round nut)	2ea 
Part Needed _____		Quantity _____	
Part Needed _____		Quantity _____	
Reason why (missing, scratched, broken glass, bent, bad finish)			
Comments _____			

FIXTURE ASSEMBLY INSTRUCTIONS

Read and review installation instruction sheet before assembling the fixture.

- Slide the Glass Shade (H) over Socket(G) and secure Glass Shade (H) by threading the Socket Ring(I) to Socket (G) until tight.
- Install the light bulb in accordance with the fixture's specifications.
(DO NOT EXCEED MAXIMUM WATTAGE RATING!)

NOTE: INSTALL THE GLASS ASSEMBLY AFTER THE FIXTURE IS HUNG.

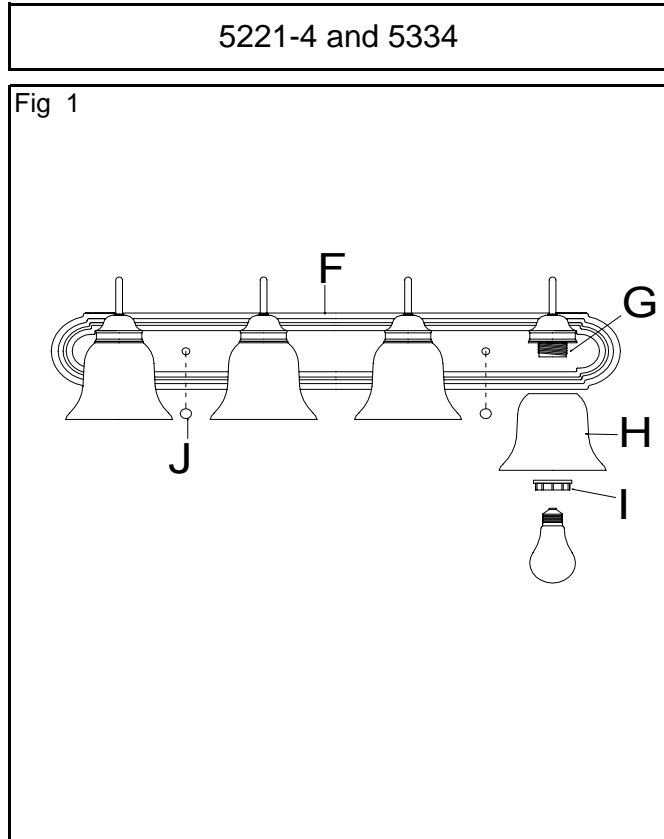

WARNING ! SHUT OFF POWER AT FUSE OR CIRCUIT BREAKER.

HANGING THE FIXTURE(Fig.1)

1. Carefully remove the new fixture from the carton and the yellow bag that holds all your parts. Check that all parts are included as shown in the illustration and parts list.

2. Shut off power at the circuit breaker and remove the old fixture from wall, including the old mounting strap.

3. Hold Mounting Plate(B) up against the wall aligning the two holes in the Junction Box with appropriate slots in the Mounting Plate(B). Then while the Mounting Plate(B) is leveled horizontally, use a pen or pencil to make a mark on the wall at holes located near each end of mounting Plate(B). Set aside the Mounting Plate(B) and insert Wall Anchors (A) into the two marks made on the wall.

4. Thread the supply wires and ground wire from Junction Box through center holes in Mounting Plate(B).

5. Attached the Mounting Plate(B) to Junction Box by using the two Junction Box Screws(E). If Anchors (A) were attached to the wall, secure the Mounting Plate (B) with two Anchors Screws(C) to corresponding holes.

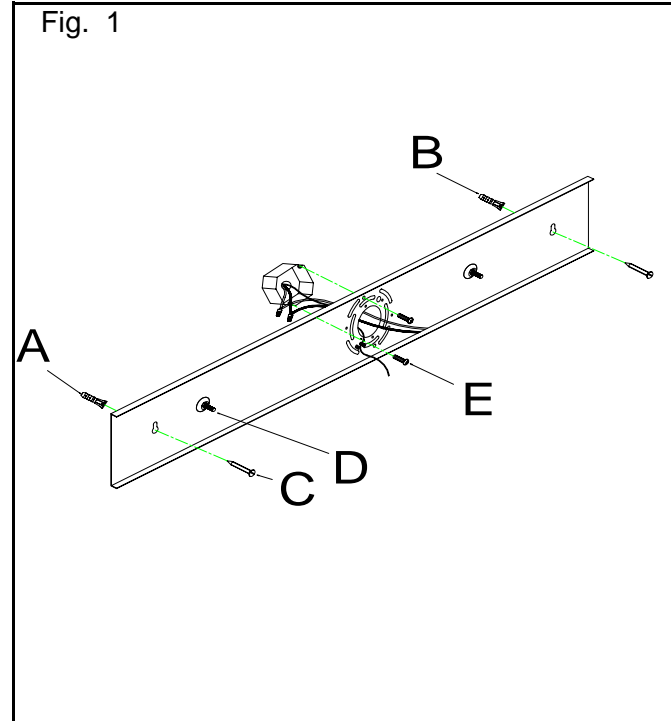

CONNECTING THE WIRES (Fig 2)

6. Attach the power supply wires to the fixture lead wires by connecting BLACK to BLACK (or SMOOTH) and WHITE to WHITE (or RIBBED).

7. Attach the GROUND wire(GREEN or COPPER) from the Junction Box and the fixture Ground wire to the green Ground Screw on the Mounting Plate (B) or connect both wires together using the correct size of wire connectors.

NOTE: Twist the wires together in the same direction you twist the wire connector onto the wires.

8. Tuck these wire connections neatly into the Junction Box.

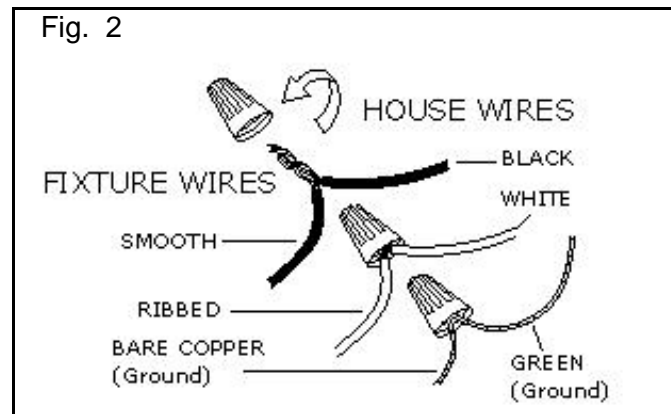

FINISHING THE INSTALLATION(Fig.3)

9. After tucking these wire connections neatly into the Junction Box and place the fixture Front Plate(F) over the two Mounting Screws(D) and secure against the Mounting Plate by threading two Deco Nuts(J) over the two Mounting Screws(D) until snug against the wall.

10. Install the light bulbs and glass shade as per the fixture assembly sheet.

YOUR INSTALLATION IS NOW COMPLETE.
RETURN POWER TO THE JUNCTION BOX AND TEST THE FIXTURE.

