

Fixture Name: Loretto 4002-FM RSB

For Flush mount Fixture

WARNING ! SHUT OFF POWER AT FUSE OR CIRCUIT BREAKER.

HANGING THE FIXTURE(Fig.1)

1. Carefully remove the new fixture from the carton and the yellow bag that holds all your parts. Check that all parts are included as shown in the illustration and parts list.
2. Shut off power at the circuit breaker and remove the old fixture from ceiling, including the old mounting strap.
3. Thread the two Fixture Mounting Screws (A) into the pre-drilled Holes in the Mounting Strap (B) spaced the same distance apart as the holes in the Ceiling Pan (D). Secure in place with the Small Hex nuts (E).
4. Attached Mounting Strap (B) to the junction box using the two Screws (C) from the Outlet Box. The side of the mounting strap marked "GND" must face out.
5. While holding the Ceiling Pan (D) toward the ceiling, Connect the electrical wires as follows.

CONNECTING THE WIRES (Fig 2)

6. Attach the power supply wires to the fixture lead wires by connecting BLACK to BLACK (or SMOOTH) and WHITE to WHITE (or RIBBED).
7. Attach the GROUND wire(GREEN or COPPER) from the Junction Box and the fixture Ground wire to the green Ground Screw on the Mounting Bracket (B) or connect both wires together using the correct size of wire connectors. -

NOTE: Twist the wires together in the same direction you twist the wire connector onto the wires.

8. Tuck these wire connections neatly into the Junction Box.

FINISHING THE INSTALLATION(Fig.3)

9. Finish mounting the Ceiling Pan (D) by placing it over the Mounting Strap (B). Rotate the Pan until the Mounting screws(A) protrude through the "Keyholes" located in the bottom of Ceiling Pan (D). Secure the Ceiling Pan (D) by screwing Ball Nuts (F) on the Mounting Screws until taut.
10. Install glass as per the fixture assembly instructions.

YOUR INSTALLATION IS NOW COMPLETE. RETURN POWER TO THE JUNCTION BOX AND TEST THE FIXTURE.

Fig 1

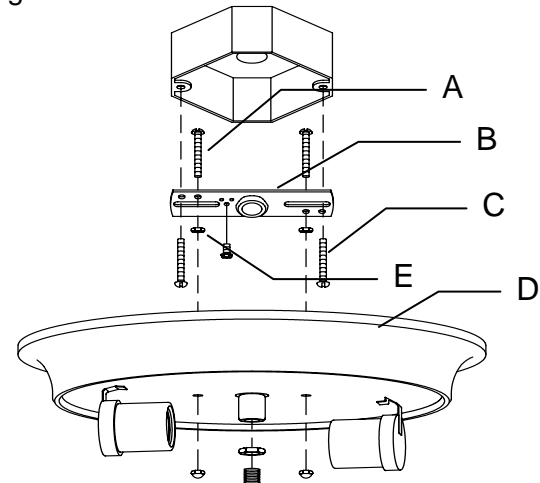

Fig.2

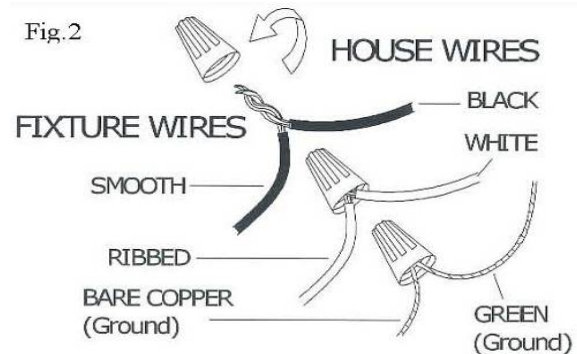
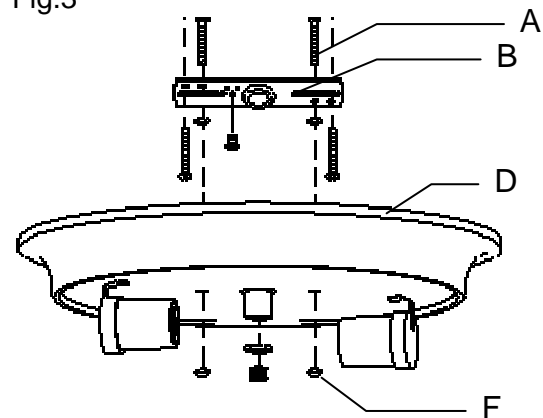













Fig.3



Fixture Name: Loretto 4002-FM RSB

This fixture assembled PO: _____ Date: _____

Notice: Please review the parts listing and check for all parts before assembling the fixture. If any parts are missing or damaged, please note on this sheet and contact the place of purchase to arrange for replacement parts.

PARTS LIST		Company Name: _____ Co. Account #: _____			
below to be filled out by retailer					
Mounting Strap	1ea 	Green Screw	1ea 	Finial	1ea 
Wire Connectors	3ea 	Nipple (125mm)	1ea 	Small Hex Nut	2ea 
Mounting Screws	4ea 	Washer	2ea 	Big Hex Nut	3ea 
Ball Nut	2ea 	Bottom Cap	1ea 		
Part Needed	_____			Quantity	_____
Part Needed	_____			Quantity	_____
Reason why	(missing, scratched, broken glass, bent, bad finish)				
Comments	_____				

FIXTURE ASSEMBLY INSTRUCTIONS

Read and review installation instruction sheet before assembling the fixture.

1. Thread the Nipple (B) into the Ceiling Pan (A) and secure with a Large Hex nut.
2. Place the Glass Shade (C) over the Ceiling Pan (A) allowing the Nipple (B) to protrude through the bottom hole in the glass and secure with Washer and Large Hex nut.
3. Place the Scrolled Cage (D) over Nipple (B) and secure with washer and Large Hex nut.
4. Slide Bottom Cap (E) over Nipple (B) and thread the Finial (F) until taut.
5. Install the bulbs as per specifications. (no bulbs included in the package).
(DO NOT EXCEED THE MAXIMUM WATTAGE RATING!)

NOTE: INSTALL THE GLASS ASSEMBLY AFTER THE FIXTURE IS HUNG.

